



The eBike Display  
**User Manual**

**KD718-X**

## Product name and model

Name: Intelligent colored LCD display for E-bike  
Model: KD718-X

## Specifications

- 36V/48V Power Supply
- Rated working current: 10mA
- The maximum working current: 30mA
- Off-state leakage current:  $<1\mu\text{A}$
- Operating temperature:  $-20^{\circ}\text{C} \sim 60^{\circ}\text{C}$
- Storage temperature:  $-30^{\circ}\text{C} \sim 70^{\circ}\text{C}$

## Appearance and Size

- ◆Display appearance and dimensional drawing (unit: mm)

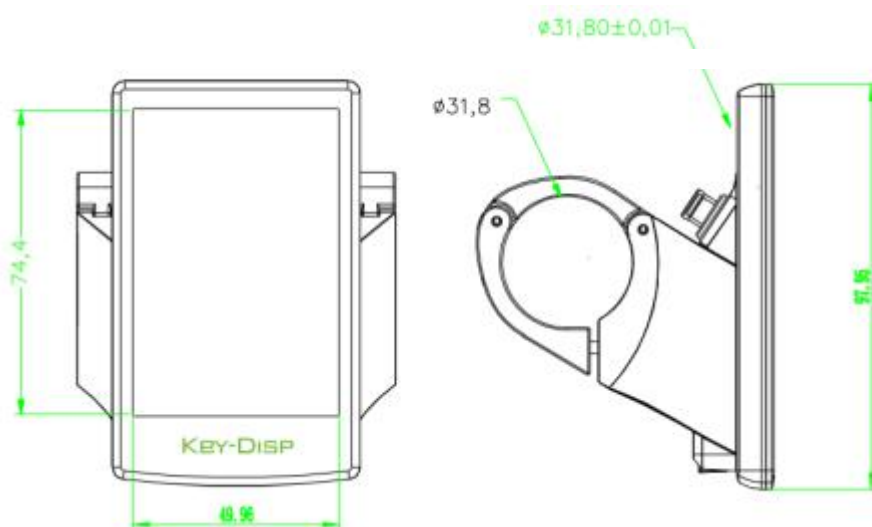

◆ Remote control appearance and dimensional drawing (unit: mm)

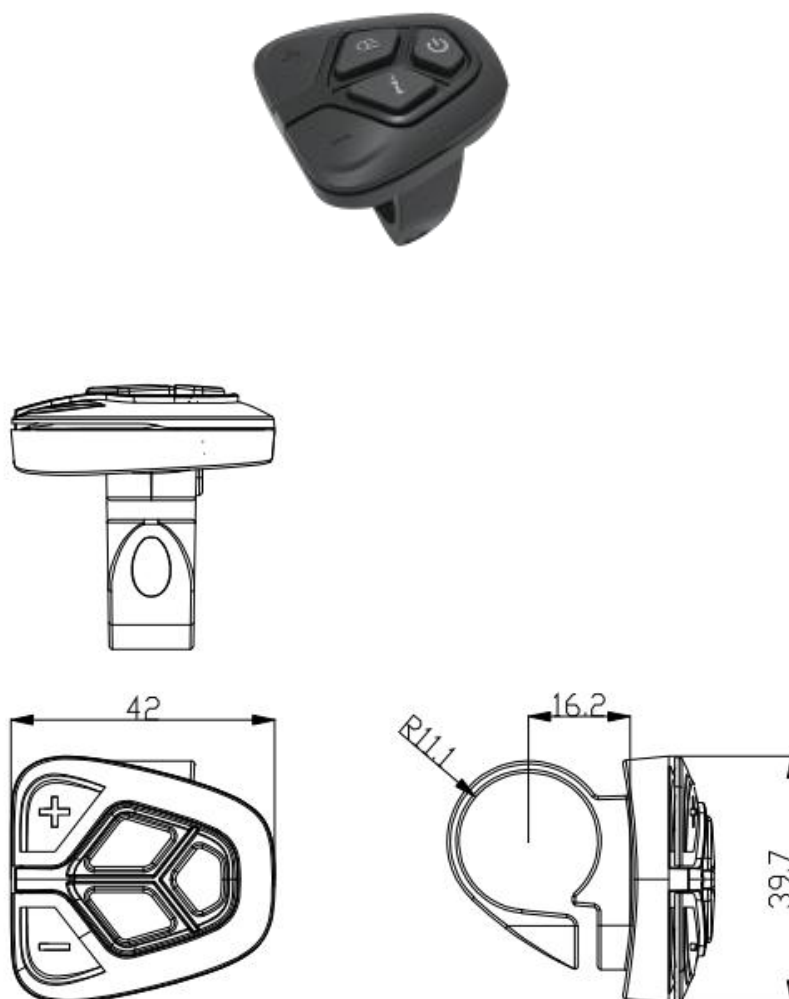

## Function Summary

KD718-X can provide a lot of functions to fit the Users needs. The indicating factors are as follows:

- Intelligent Battery SOC indication
- Motor Power indication
- Assist-level indication and selection
- Speed indication (incl. Real-time speed, Max. speed and Ave. speed)
- Odometer and trip distance
- Push-assistance control and indication
- Trip time indication
- Backlight On/Off and indication
- Error code indication
- USB connection indicator
- Various Parameters Settings (e.g., wheel size setting, speed limit setting, battery voltage segmented value setting, power assist parameters setting, etc.)

## General Operation

### ◆Switching the E-bike System On/Off

Briefly press the power button to switch on the E-bike system.

When display is on, hold the power button for 2s, the E-bike system will be switched off and no longer uses the battery power.

When switching off the E-bike system, the leakage current is less than 1  $\mu$ A.

■When parking the E-bike for more than 5 minutes, the E-bike system switches off automatically.

### ◆Display Interface

After switching on the E-bike system, the display will show real-time Speed and Trip Distance by default. Press the “i” button to switch between following elements:

Trip (Km) → ODO (Km)→Max. Speed (Km/h)→ Avg. Speed (Km/h) →Time (Min.) .



Display Indication Cycle Interface

### ◆Switching Push-assistance Mode On/Off

To activate the push-assistance function, keep holding the “-” button. After 2s, The E-bike’s drive is activated at a speed of less than 6 Km/h while the screen displays “”. The push-assistance function is switched off as soon as you release the “-” button on the operating unit .The E-bike system stops the power output immediately.

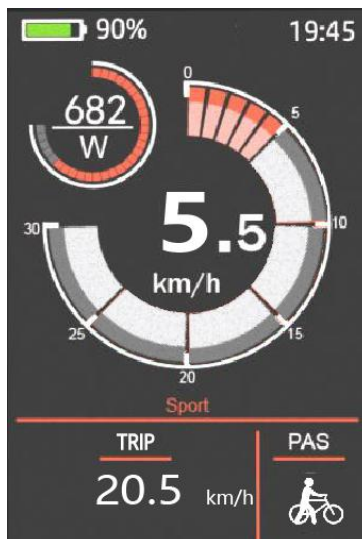

Push-assistance Mode

■Push-assistance function may only be used when pushing the E-bike.

Be aware of danger of injury when the wheels of the E-bike do not have ground contact while using the push-assistance function.

### ◆Switching the Lighting On/Off

To switch on the bike light, hold the + button. The backlight brightness is automatically reduced. Hold the + button again, the lighting can be switched off.

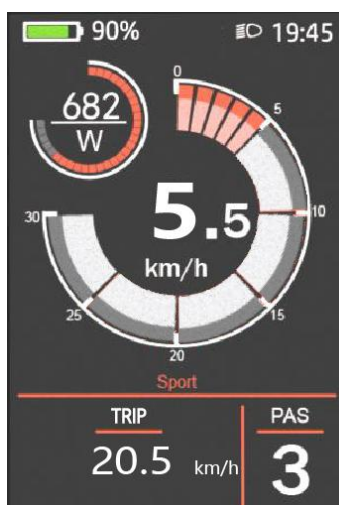

Switching the Lighting Mode On/Off Interface

### ◆ Assist Level Selection

Briefly press "+" or "-" button to switch between assistance levels so as to change the motor output power, The default assistance level ranges from level "0" to level "5" , The output power is zero on Level "0" . Level "1" is the minimum power. Level "5" is the maximum power. When you reach "5" , press the "+" button again, the interface still shows "5" , and blinks at "5" to indicate the power highest. After the power downshift reaches "0" , press the "-" button again, the interface still shows "0" and blinks at "0" to indicate the power minimum. The default value is level "1" .

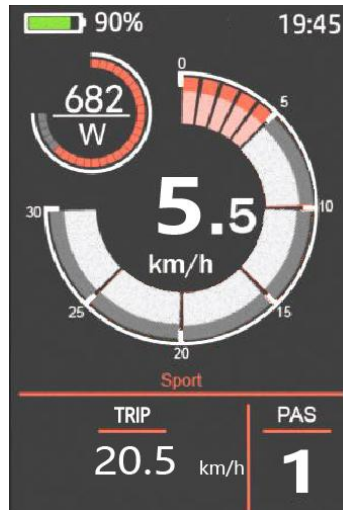

Assist Level Toggling Interface

### ◆ Battery SOC Indicator

The five battery bars represent battery SOC. The five battery segments are bright when the battery is in high voltage. When percentage is 0%, the battery needs to be recharged immediately.



Battery SOC Indication Interface

### ◆ Motor Power Indicator

The output power of the motor can be read via below interface

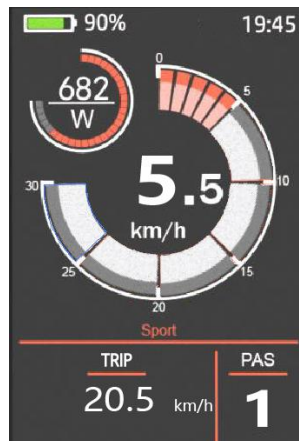

Motor Power Indication Interface

◆USB connection indication

When the display is inserted into a USB external device, the display interface will show as below.

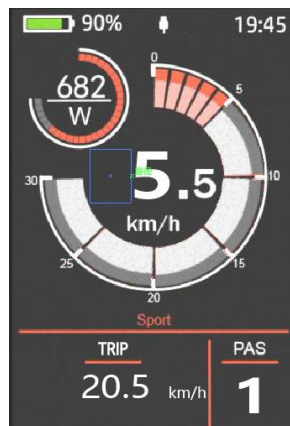

USB Connection Indication Interface

◆Error Code Indication

The components of the E-bike system are continuously and automatically monitored. When an error is detected, the respective error code is indicated in text indication area.

Here is the detail message of the error code in **Attached list 1**.

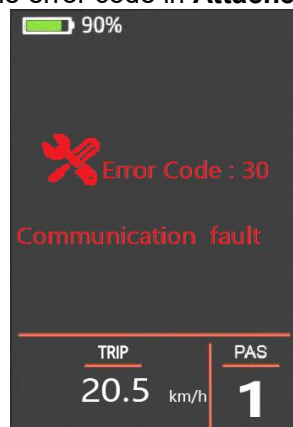

Error Code Indication

■Have the display repaired when error code appears. Otherwise, you will not be able to ride the bike normally. Please always refer to an authorized dealer.

## Setting

Press the **On/Off** button to switch on the display on a stationary E-bike.  
To access Setting page, hold both the “+” button and the “-” button for 2s.

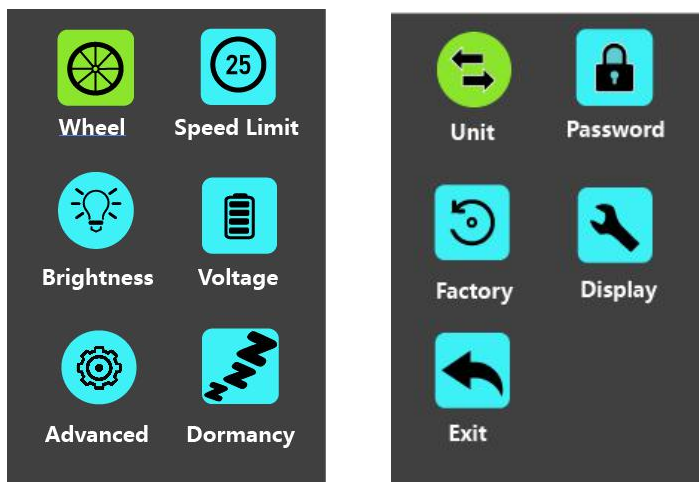

Setting interface

■ All the Settings are operated on an E-bike of no speed.

### ◆ Wheel Diameter Settings

**Wheel** represents wheel diameter settings. To change basic settings, press the “+” or the “-” button to increase or decrease until the desired value is displayed. The default value is 26 inch.

To store a changed setting, press the “i” button to confirm.

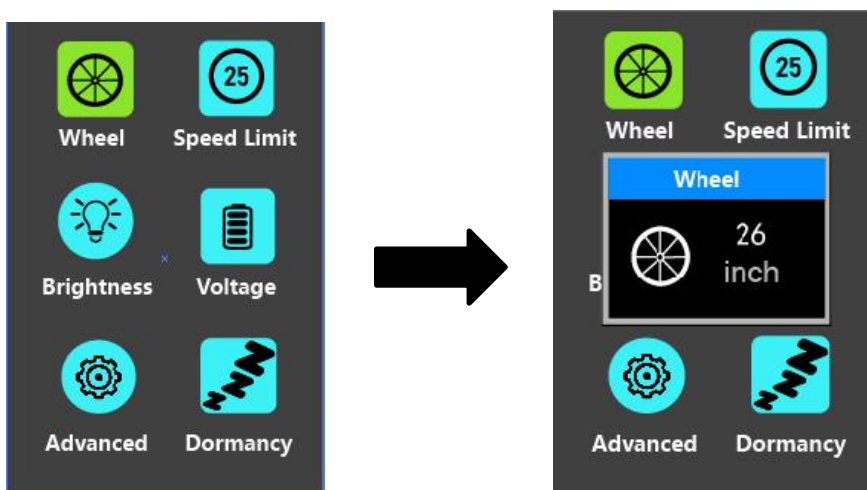

Wheel Diameter Settings Interface



### ◆Speed-limit Settings

**Speed Limit** represents the limited speed settings. When the current speed is faster than speed limit, the E-bike system power output will be reduced. Speed limit range is 15Km/h to 40Km/h. The default value is 25Km/h.

To change basic settings, press the “+” or the “-” button to increase or decrease until the desired value is displayed.

To store a changed setting, press the “i” button to confirm.

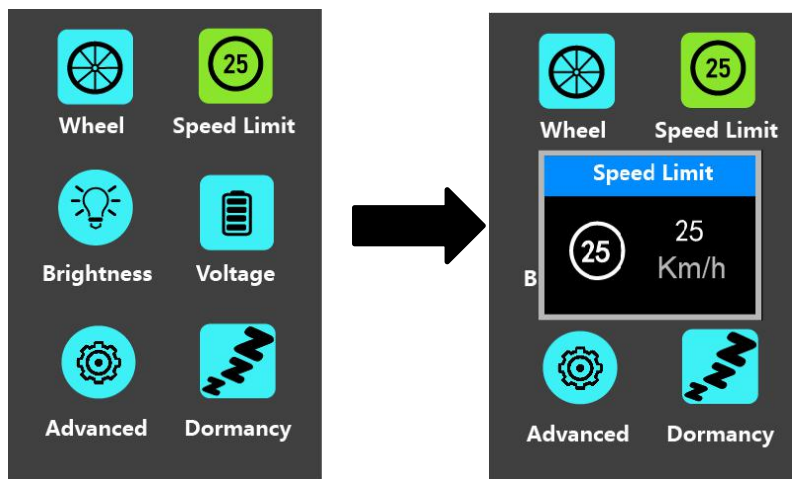

Speed limit settings interface

### ◆Backlight Brightness Settings

**Brightness** represents backlight brightness settings. Level 5 is the highest brightness. The less the level value, the lower the backlight brightness.

To change the backlight brightness, press the “+” button or the “-” button to choose the desired percentage.

To store a changed setting, briefly press the “i” button to confirm.

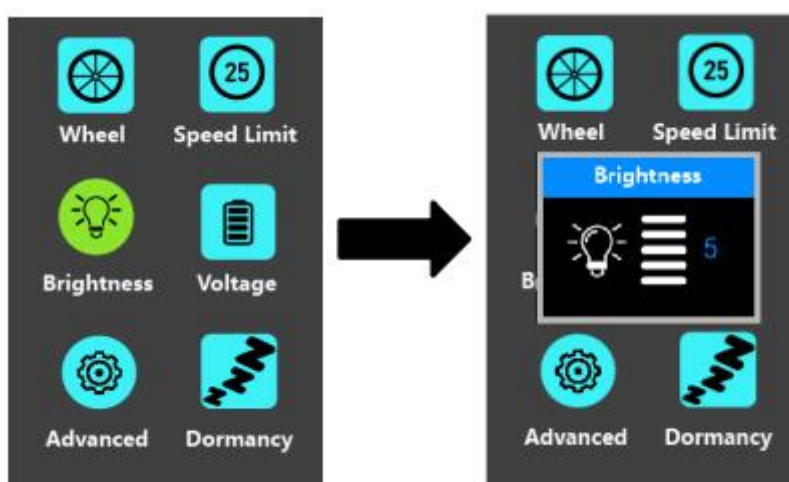

Backlight Brightness Settings Interface

### ◆ Battery Power Bar Settings

**Voltage** represents battery voltage segmented value settings. 36V/48V switchable.

5 bar-voltage values for 36V or 48V must be entered one by one. Take 48V for example, "1-" is the first bar voltage value and its default value is 41.2V.

To set battery power bar value, press the "+" or the "-" button to increase or decrease the voltage values.

To store a changed setting and access the next bar voltage setting, press the "i" button.

In the same manner, after 5 bar-voltage values are entered completely, press the "i" button to confirm.



Battery Voltage Settings Interface

### ◆ Advanced settings

**Advanced** setting here deals with PAS parameters settings

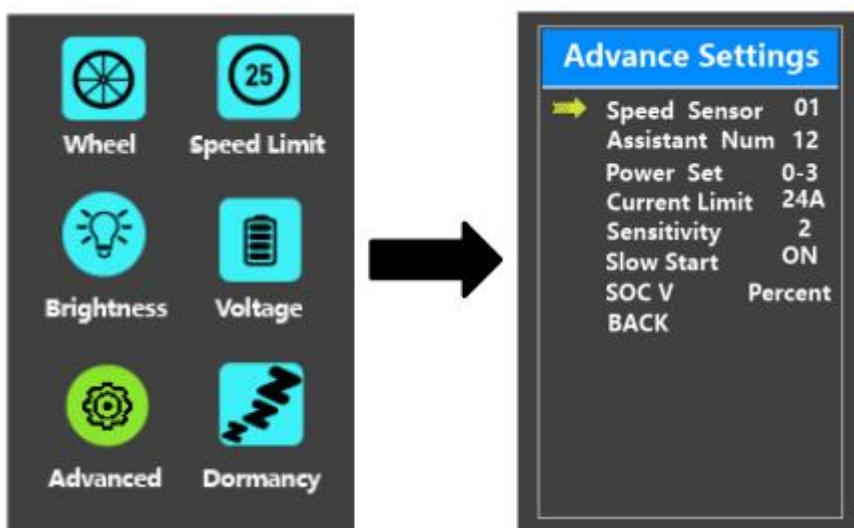

Advanced setting interface

### ◆Speed Sensor

**Speed Sensor** represents speed sensor magnet numbers settings.

To change speed sensor settings, press the “+” or the “-” button to set the numbers of magnets on the e-bike spoke (the range is from 1 to 15). The default value is 1.

To store a changed setting, press the “i” button to confirm.

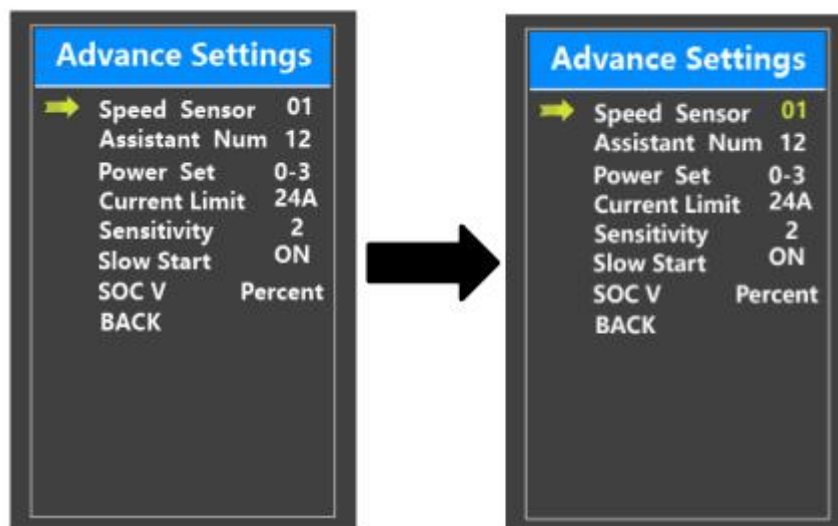

Speed sensor setting

### ◆Power Assistant Sensor Magnets

**Assistant Num** represents the number of magnets on the PAS disk. The settable range is “5” to “24”. The default value is 12.

To change the magnet numbers for the power assist sensor, press the “+” or the “-” button to choose the desired number.

To store a changed setting, press the “i” button to confirm

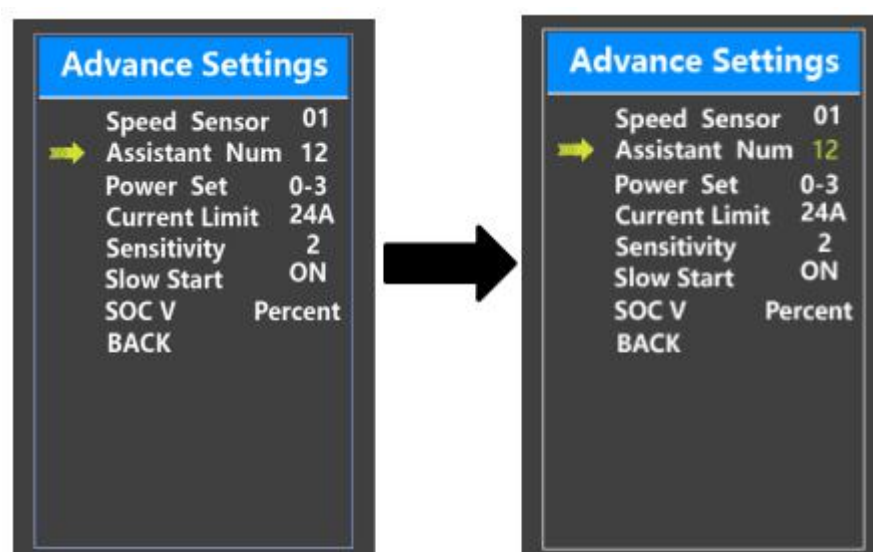

Assistant Num setting interface

## ◆ Assist Level Settings

### Assist Level Mode Options

**Power Set** represents assist level settings. In assist level mode settings, there are 8 modes for your choice: 0-3, 1-3, 0-5, 1-5, 0-7, 1-7, 0-9, 1-9. The default mode is 0-5.

To change assist level mode, press the “+” or the “-” button to choose the desired mode and press the “i” button to confirm and access assist level ratio settings automatically.

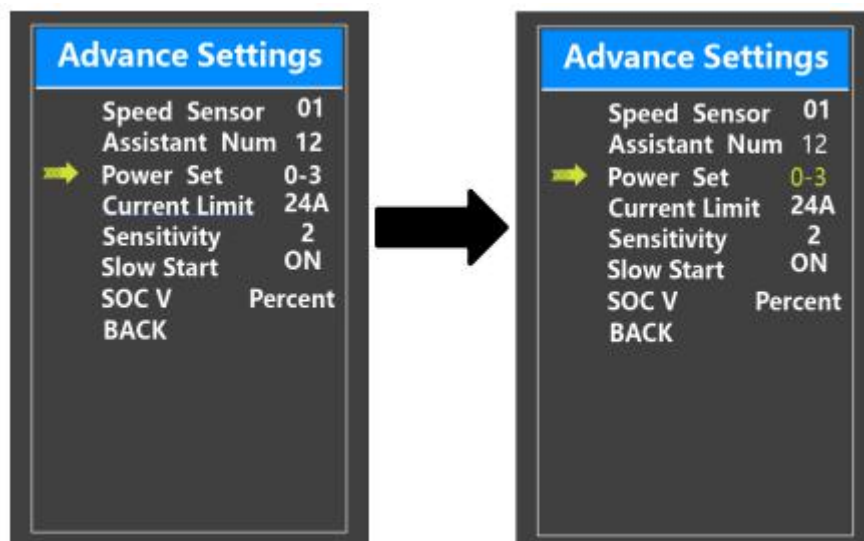

Assist Level Mode Settings Interface

## ◆ Current limit Settings

**Current Limit** represents controller over-current cut settings. The current value can be changed from 7.0A to 25.0A. The default value is 15A.

To change basic settings, press the “+” or the “-” button to increase or decrease the value of the current.

To store a changed setting, press the “i” button to confirm.

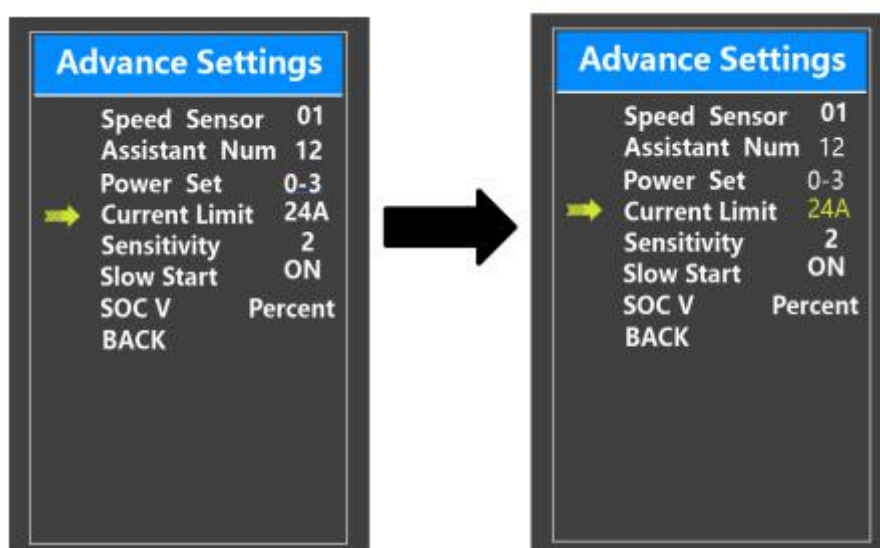

Current limit setting

### ◆Sensitivity

**Sensitivity** represents the sensitivity of power assist sensor. It means the motor assist should start after a certain number of magnets are passing the power assist sensor.

To change the value, press the “+” or the “-” button to choose the sensitivity value. The default value can be customized.

To store a changed setting, press the “i” button to confirm

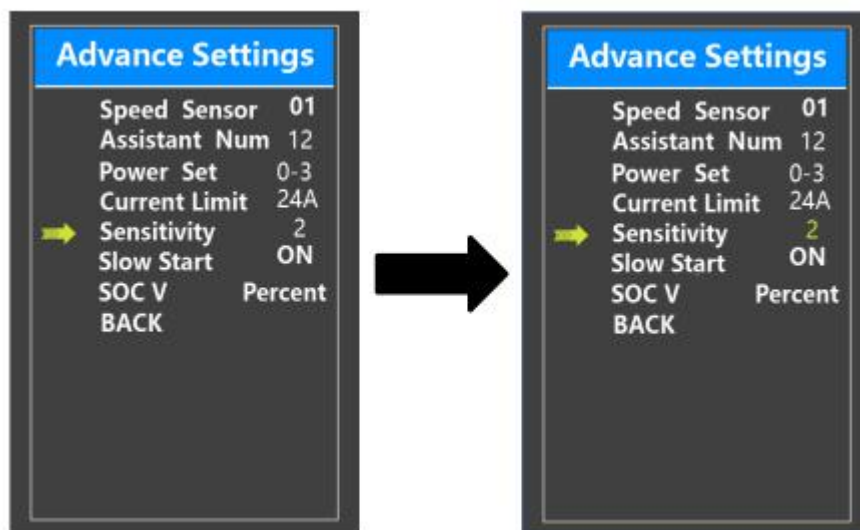

Sensitivity setting interface

### ◆Slow start

**Slow start** represents slow start-up settings. It is a time duration before you get power assistance when stepping into the pedals. The range is “0-3”. “3” is the slowest. The default value is “1”.

To change slow start up settings, press +/- button to choose the desired value. And press the i button to confirm and store a changed setting.

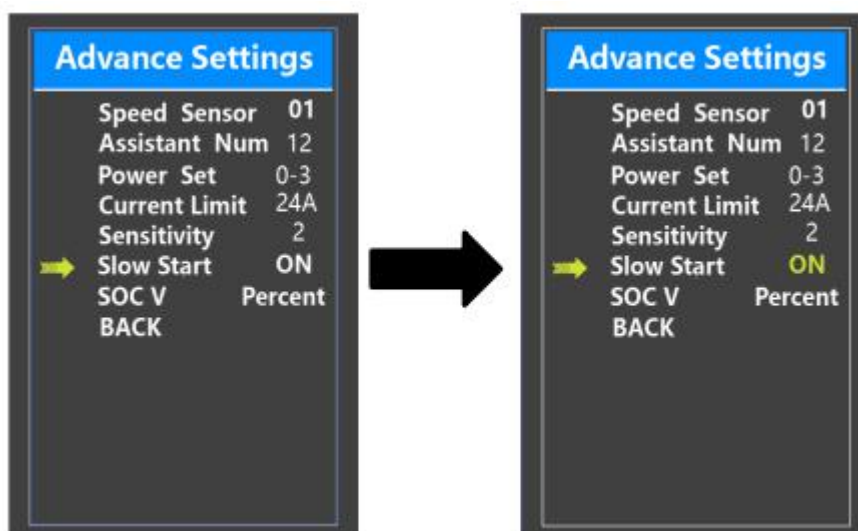

Slow start setting

◆SOC View Settings

SOC V represents 2 display modes of battery SOC. One is by the percent value and the other is by the Voltage value. Press the “+” button or the “-” button to choose the desired display method. The default view method is by the percent.

To store a changed setting, briefly press the “i” button to confirm.

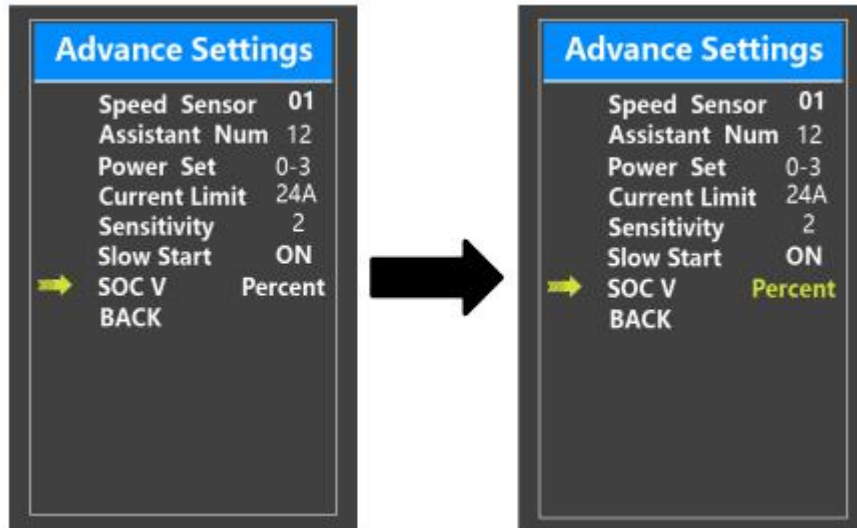

SOC view setting interface

◆Auto-off Time Settings

Dormancy represents display auto-off time settings.

To change display automatic shutdown time, press Dormancy and press the “+” button or the “-” button to choose the desired duration. The default auto-off time is 5 minutes.

To store a changed setting, briefly press the “i” button.

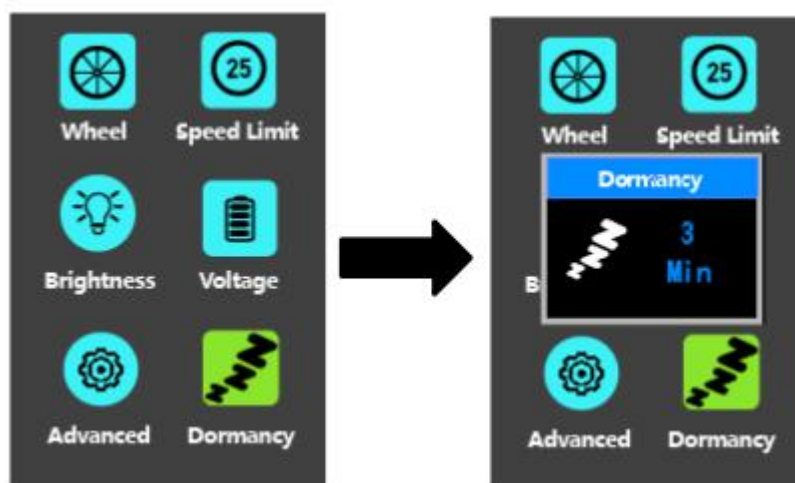

Auto-off time settings



### ◆Unit km/mile toggling

**Unit** represents unit toggling settings.

To toggle the unit, press the “+” button or the “-” button to choose the desired unit and press the “i” button to confirm. The default unit is “Metric (km)”.

To store a changed setting, briefly press the “i” button to confirm.

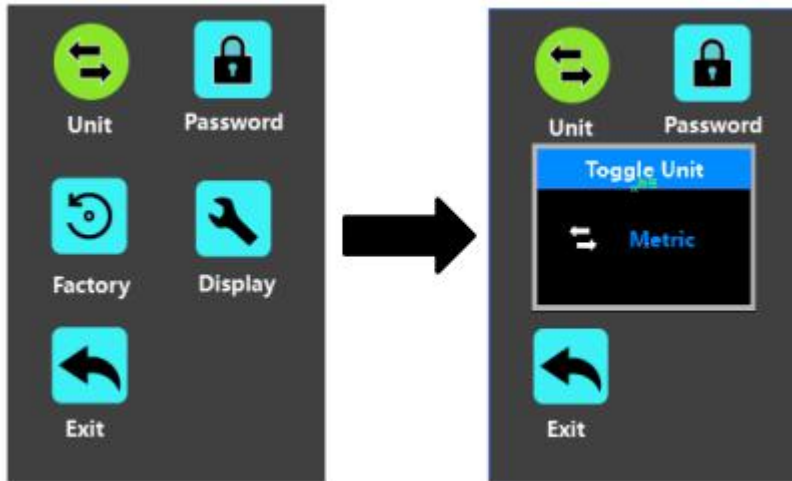

Mile and Kilometer Toggling Interface

### ◆Password Settings

**Password** means display power-on password settings

To access the power-on password setting page, select '**Password**' in the menu and press “i” button to confirm.

**PassWord Set** means power-on password settings. Power-on password is a 4-digit code. The default password is '1212'.

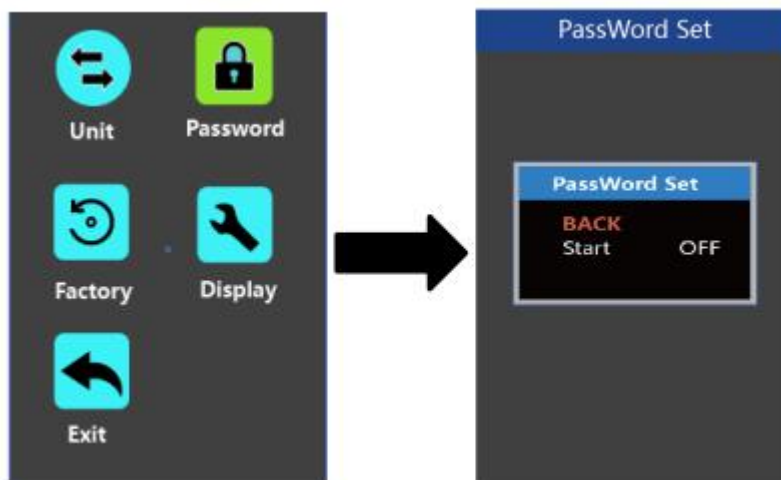

Password Setting Interface

## 1.Power-on Password Disable/Enable

To enable or disable **Start PassWord** settings, press the “+” or the “-” button to select ON or OFF. ON means enabling a power-on password while OFF means disabling a power-on password. The default value is OFF.

To enable a power-on password, choose ON and press “i” button to confirm and input the current password or default password ‘1212’. Press the “+” or the “-” button to change the number and press the “i” button to confirm digits one by one until the correct password ( *current password or default password ‘1212’* ) is completed.

To disable the current password, choose OFF and press “i” button to confirm and input the current password correctly. The screen displays ‘PassWord Canceled Successfully’. **\*Then the display password is restoring the default code ‘1212’.**



Password Enable/Disable Settings Interface

## 2.Power-on Password Reset

From the last interface above, press the “+” or the “-” button to select '**Reset PassWord**' and press the “i” button to confirm to access power-on password reset interface. There are 3 pages for setting up a new password:

In the **first** page, please enter the current password or default password ‘1212’ correctly.

Then it moves to the **second** page for inputting a new password. Press the “+” or the “-” button to increase or decrease the number and then press the “i” button to confirm digits one by one until a new 4-digit password is completed.

Finally, it comes to the **third** page and reenter the new password again for confirmation. The screen displays ‘PassWord Reset Successfully’

When switching on the E-bike system next time, please enter the new password to power on the display.





Password Change Interface

### ◆Factory settings

Factory means restoring to default settings .

To reset to defaults, press the “+” or the “-” button to choose YES or NO. The default is NO.

To store a changed setting, press the “!” button to confirm.

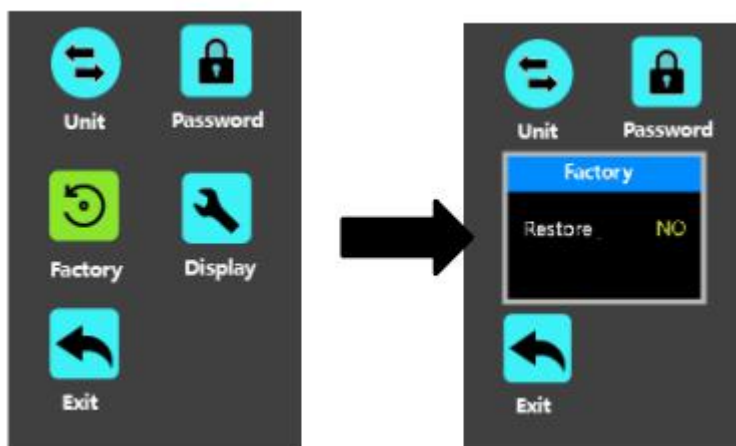

Factory settings

## ◆Display settings

Display means display basic parameter settings, for example, trip reset etc..

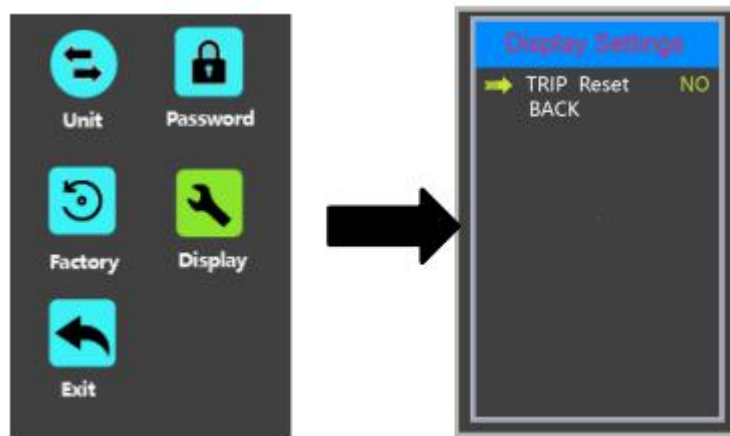

Display settings

## ◆Trip Distance Clearance

**Trip Reset** represents trip distance clearance setting.

To clear trip distance, press the “+” button or the “-” button to select Yes or No. Yes represents clearing a single ride distance. No represents not clearing a single ride distance.

To store a changed setting, briefly press the “i” button to confirm.



Trip Distance Clearance Settings Interface

### ◆Exit Settings

**Exit** means return back to home screen from setting pages.



■If there is no operations in one minute; the display will exit the settings state automatically.

## Quality Assurance and Warranty Scope

### I Warranty

- (1) The warranty will be valid only for products used in normal usage conditions.
- (2) The warranty is valid for 24 months after the shipment or delivery to customers

### II The following cases do not belong to our warranty scope.

1. The display is demolished.
2. The damage of the display is caused by wrong installation or operation.
3. Shell of the display is broken when the display is out of the factory.
4. Wire of the display is broken.
5. The fault or damage of the display is caused by the force majeure (e.g., fire, earthquake, etc.).
6. Beyond Warranty period.

## Connection Layout

### Standard connector wiring

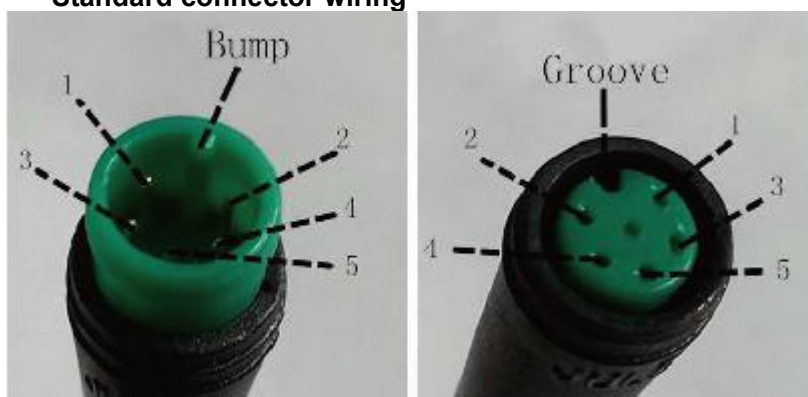

Display-side connector

mating connector from controller side

### wire sequence table

Wire no.	Color	Function
1	Red (VCC)	Display power cable
2	Blue (K)	Controller power control cable
3	Black (GND)	Ground/earth
4	Green (RX)	Display end- RX
5	Yellow (TX)	Display end-TX

■Some displays have wire connection with water-proof connectors, users can not see the color of lead wires in the harness.

**Warnings:**

- ◆ Use the display with caution. Don't attempt to release or link the connector when battery is on.
- ◆ Try to avoid hitting the display.
- ◆ Don't modify system parameters to avoid parameter disorder.
- ◆ Make the display repaired when error code appears.

*\*This manual instruction is a universal version for **DISPLAY KD718-X**. Some versions of this display may be different from specification to specification as to the software. Please always refer to an actual version.*

**Attached list 1: Error code definition**

<b>Error Code</b>	<b>Definition</b>
21	Current Abnormality
22	Throttle Abnormality
23	Motor Phase Abnormality
24	Motor Hall Signal Abnormality
25	Brake Abnormality
30	Communication Abnormality